

版本 REV.	日期 DATE	ECN NO.	变更内容 DESCRIPTION	制图 DRAWN

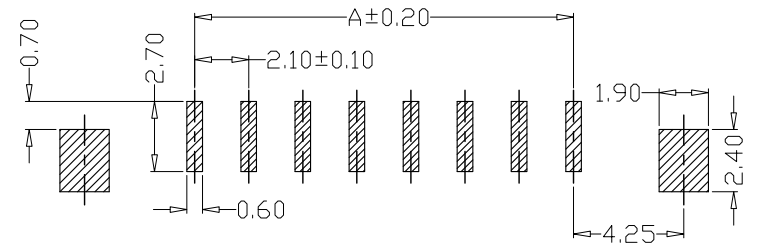

PCB LAYOUT

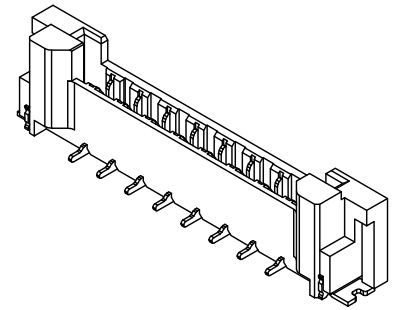
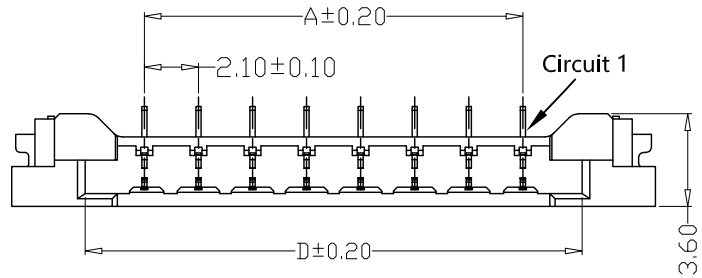
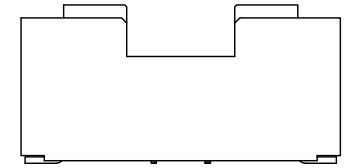
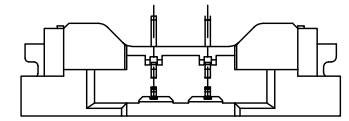
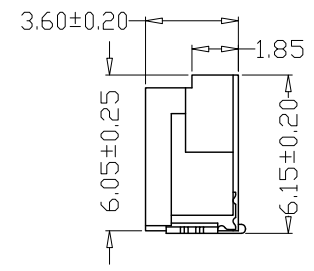
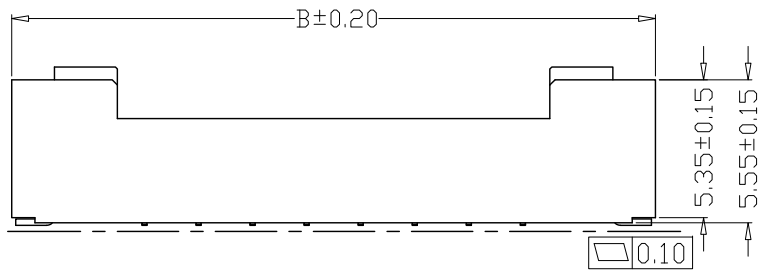

02AB

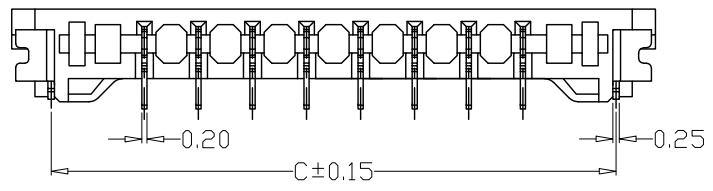

SPECIFICATIONS

- 1、Current Rating: 1A AC, DC
- 2、Voltage Rating: 250V AC, DC
- 3、Temperatuer Range: -25°C ~ +85°C
- 4、Contact Resistance: 30mΩ Max
- 5、Insulation Resistance: 1000MΩ Min
- 6、Withstanding Voltang: 1500V AC/minute
- 7、Material: Wafer PA6T, UL94V-0  
PIN Phosphor bronze Tin-plated  
Solder tab Brass Tin-plated

PIN	尺寸 (mm)			
	A	B	C	D
-02AB	2.10	12.40	9.40	6.70
-08AB	14.70	25.00	22.00	19.30

GENERAL TOLERANCE		制图 Mapping	张迎春 2022、09、13		料号 PART NO.	B21002-nAB		版本 REV.	A
X±0.25	X°±2°	审核 Audit	钱岳生 2022、09、13		品名 TITLE	21002立贴 WAFER SMT TYPE		页次 SHEET	1/1
.X±0.25	.X°±1°		核准 Approved	张名 2022、09、14		客户料号 CUTM. NO.			
.XX±0.15	.XX°±0.5°	单位 Units	MM	比例 SCALE	1:1				
.XXX±0.10	.XXX°±0.5°	YueQing HongYi Electronics Co., Ltd 乐清市宏一电子有限公司							